

BICE

by e-ggs

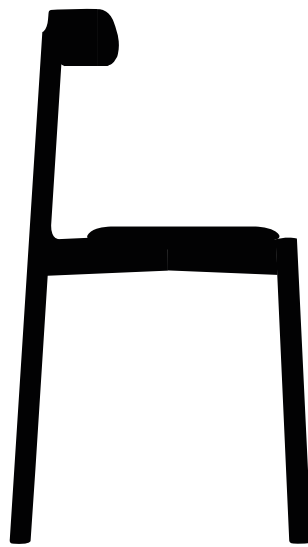

Bice è una sedia snella e a tratti insolita. Nel suo design essenziale spicca uno schienale a sventola, eccesso capace di equilibrare e caratterizzare la sua struttura.

Bice is a slim and sometimes unusual chair. Its essential design is juxtaposed by its flap-ears backrest, which balances and characterises its structure.

DIMENSIONI | DIMENSIONS

lunghezza | width: 42 cm
larghezza | depth: 47 cm
altezza | height: 79 cm
altezza del sedile | seat height: 46,5 cm
impilabilità | stackability: sì (X3) | yes (X3)

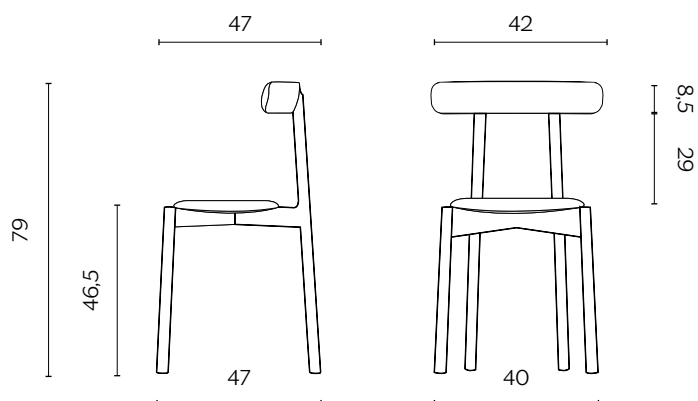

FINITURE STRUTTURA | STRUCTURE FINISHES

LEGNO | WOOD



Frassino
Ash



Frassino Tinto Rovere
Ash Stained Oak



Frassino Tinto Noce
Ash Stained Walnut



Frassino Nero
Black Ash

TESSUTI | FABRICS

A

LOOP

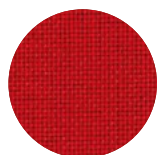

Rosso

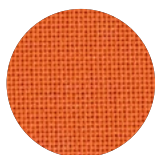

Arancione

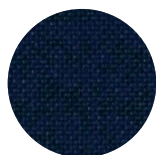

Blu notte



Cioccolato



Burro



Grigio fumo



Nero

TRAMÈ

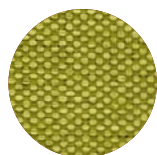

Mela

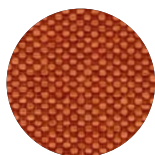

Arancio



Uva

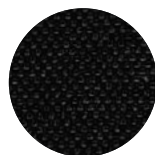

Nero



Beige

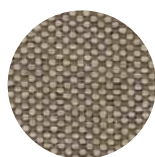

Tortora

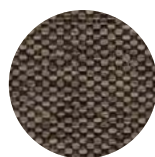

Grigio scuro

TESSUTI | FABRICS

A

CANVA



Ciallo

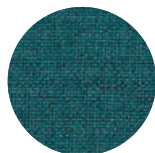

Petrolio

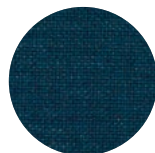

Blu



Sale



Sabbia

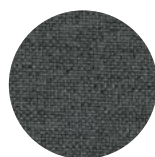

Grigio scuro

PEPLO



Cannella



Rosso mattone



Giallo ocra



Grigio chiaro



Grigio tortora



Blu notte

TESSUTI | FABRICS

B

FLUKSO PLATINUM

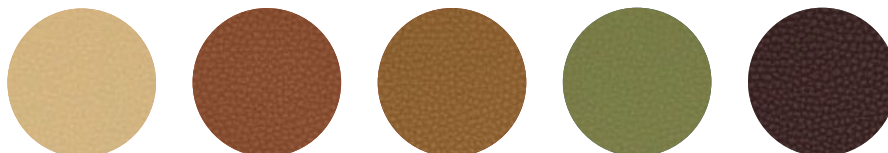

Pesca

Mattone

Nocciola

Verde

Porpora

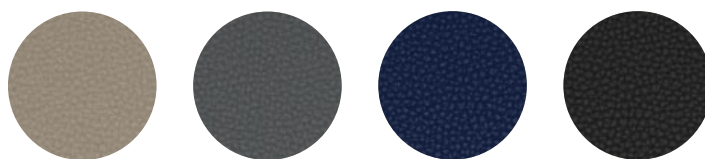

Tortora

Nuvoloso

Blu

Nero

FLUKSO REBEL ECONABUK



Nocciola

Seppia

Marrone

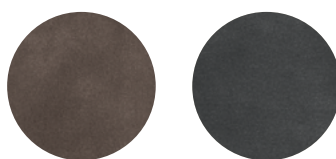

Grigio

Antracite

TESSUTI | FABRICS

B

VESCOM WILSON

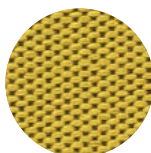

Ciallo elettrico

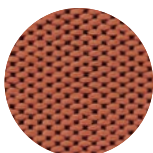

Rosé

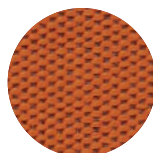

Energico

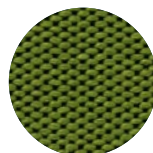

Laguna

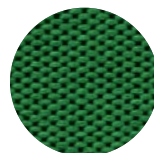

Prato

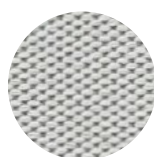

Neve

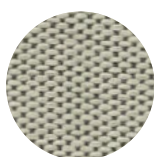

Sale e pepe

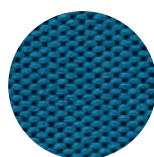

Zaffiro

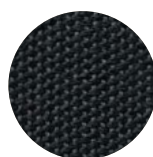

Crafite

VESCOM NORFOLK

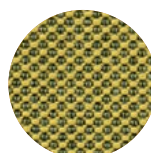

Ape

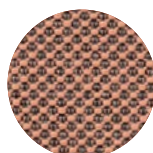

Rosa

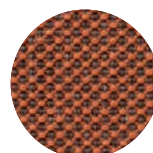

Mattone

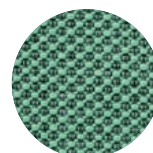

Latte e menta



Petrolio

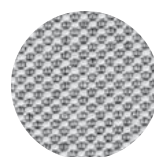

Chiaccio



Sale e pepe



Notte



Antracite

TESSUTI | FABRICS

C

KVADRAT RELATE

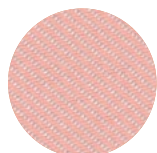

Rosa



Rosso

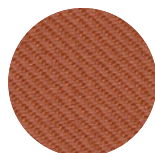

Terra



Snack



Menta

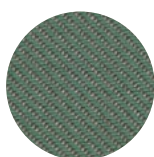

Verde bosco



Nuvolo

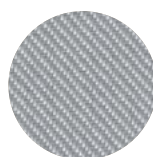

Grigio

KVADRAT FIELD 2

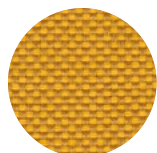

Zafferano

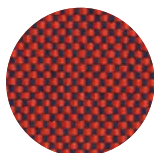

Ciliegia

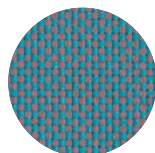

Zucchero

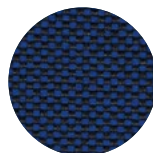

Blu

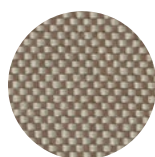

Nocciola

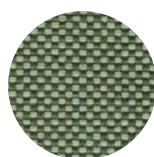

Menta

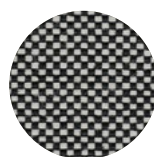

Sale e pepe

TESSUTI | FABRICS

C

VESCOM HARDING

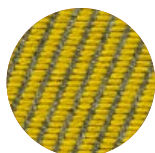

Ciallo

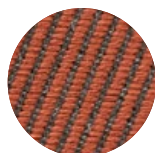

Rosso

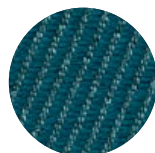

Petrolio



Nuvolo



Crigio chiaro

VESCOM ROLLA

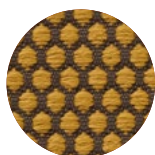

Mostarda

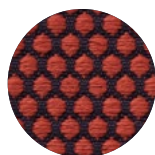

Ciliegia



Blu pavone



Latte

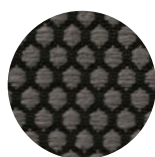

Crafite



Blu notte

TESSUTI | FABRICS

C

VESCOM MOORE



Margherita

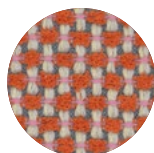

Lampone

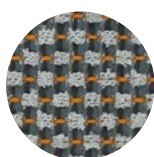

Saetta

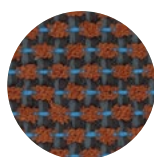

Uva

TORRILANA GUBBIO

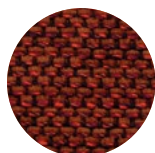

Ambra

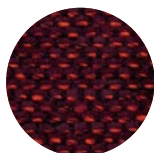

Bordeaux

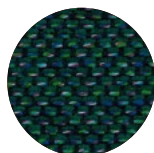

Verde Petrolio

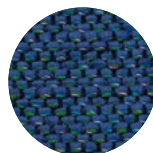

Blu elettrico

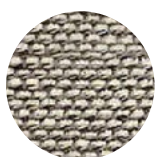

Sale e pepe



Castagna



Tortora

TESSUTI | FABRICS

C

BIG BOSS



Nuvola

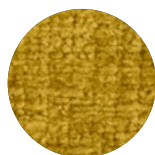

Senape



Nocciola



Turchese

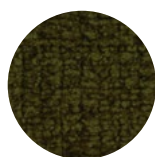

Muschio



Porpora

MAHARAM METRIC

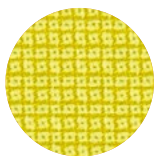

Canary



Cala



Lava

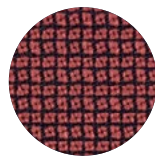

Kiln

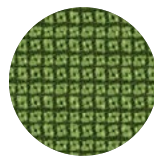

Alligator

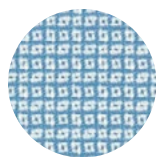

Middy



Talisman



Seaport



Film

TESSUTI | FABRICS

D

MAHARAM MERIT



Salmone

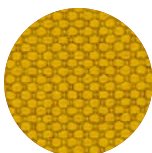

Ciallo

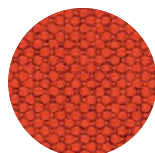

Rosso corallo

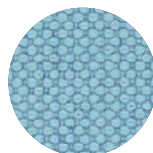

Celeste



Marrone

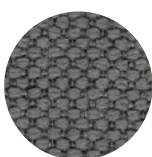

Grigio



Sale e pepe

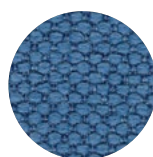

Blu cobalto

ROHI SERA

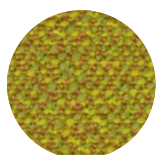

Tivoli

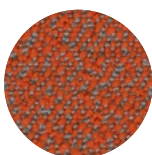

Glow

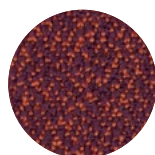

Berry

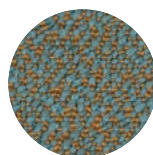

Mirage



Pepper

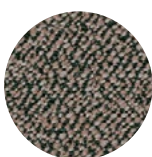

Walnut



Rosewood

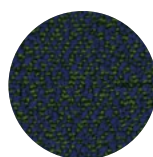

Mare

TESSUTI | FABRICS

D

ROHI MICA



Sanddorn

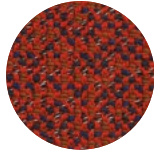

Indio

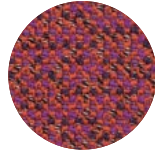

Brevia

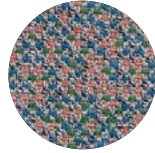

Papillon

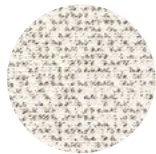

Calla



Crisp

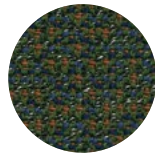

Jungle



Secret

ROHI CLEO



Lemon

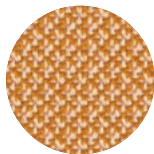

Peach

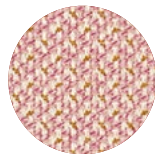

Flamingo

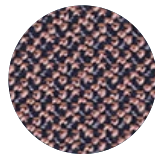

Azalee

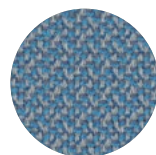

Sky



Ocean

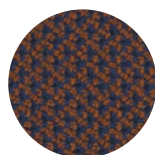

Magma



Pepper

TESSUTI | FABRICS

D

ERIMITI CLOUD



Panna



Noce



Nocciola



Bordeaux

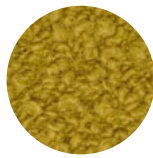

Senape

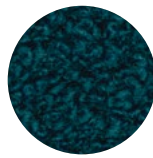

Petrolio

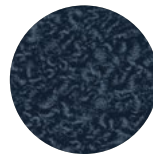

Blu notte

TORRILANA BRIONNE

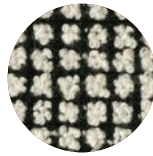

Black and white

TESSUTI | FABRICS

E

KVADRAT STEEL CUT TRIO 3

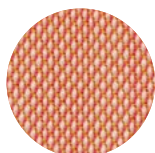

Pesca

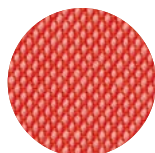

Arancia rossa

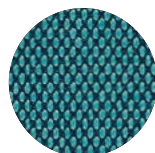

Pavone



Sale e pepe

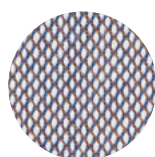

Elettricità

VELLUTO

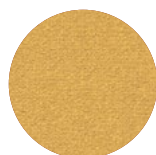

Soleggiato



Teddy



Cannella



Tobacco



Ostrica



Jeans



Notturmo

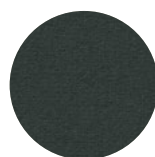

Balsamico

TESSUTI | FABRICS

E

DEDAR VOULEZ-VOUS

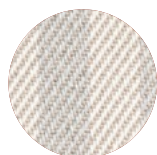

Sambuco



Cirasole

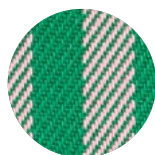

Fragola e menta



Tiramisu



Amarena



Tabacco



Noce di cocco

TESSUTI | FABRICS

F

KVADRAT SUUNTA

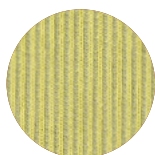

Primavera



Narcis

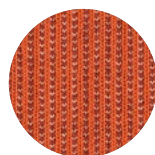

Tulip



Peony

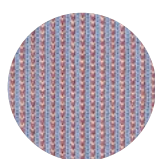

Crocus

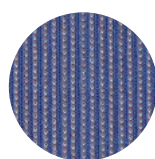

Iris

KVADRAT TERO OUT

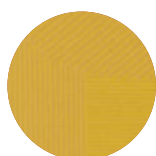

Sole



Verde prato



Borgogna



Notte



Panna



Nuvole

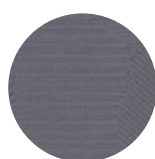

Robot



Tabacco

TESSUTI | FABRICS

F

MAHARAM OXBOW

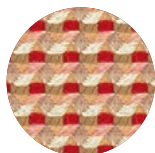

Dianthus

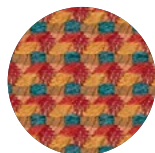

Montage

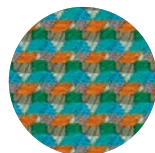

Nouveau

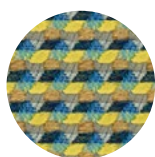

Legume

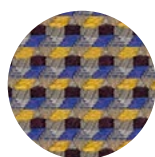

Module

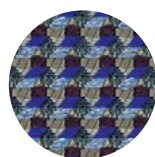

Trope

SAHCO ZERO

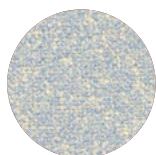

Zucchero



Candido

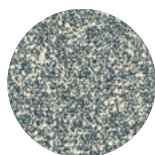

Petrolio

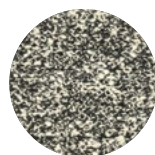

Sale e pepe

TESSUTI | FABRICS

C

DEDAR TIGER BEAT

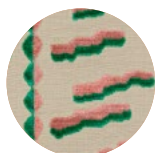

Fragola menta

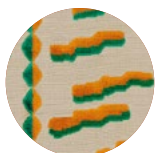

Papaya



Fauve



Tabacco



Fumo

DEDAR AMULETO



Corallo



Rubino

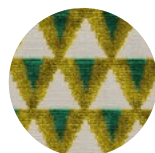

Smeraldo



Alabastro



Occhio di tigre